

# Lawmate AR-100 Audio Recording Keychain User Manual

Last Modified on 12/04/2015 12:24 pm EST

## AR-100 Covert Voice Recorder Quick Guide

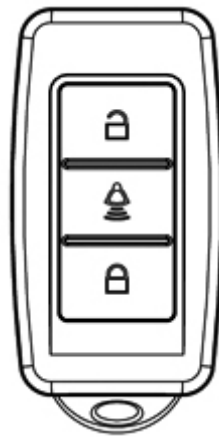

**LawMate**

**Law Enforcement Product Manufacturer V1.0**

### ■ Name and Parts

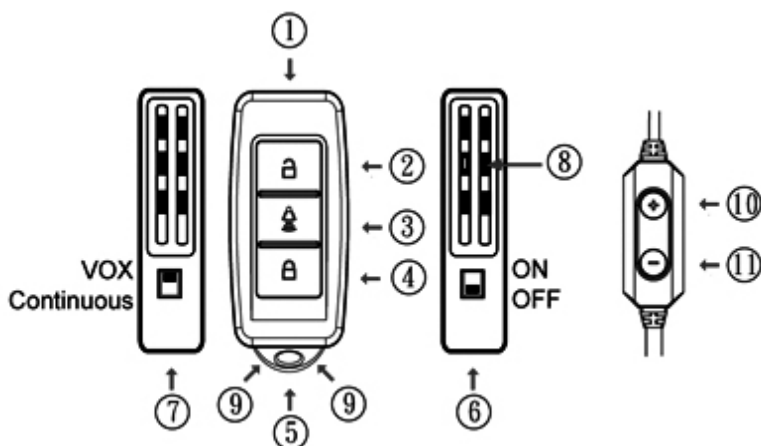

1. Microphone
2. On/Off Button
3. Rec/Stop/Delete Button
4. Play/Stop Button
5. Covert Piece

6. Vibration Switch
7. Voice Activation Switch
8. Reset Button
9. Status Indicator
10. Vol Up/Prev. File
11. Vol. Down/Next File

## ■ Package Content

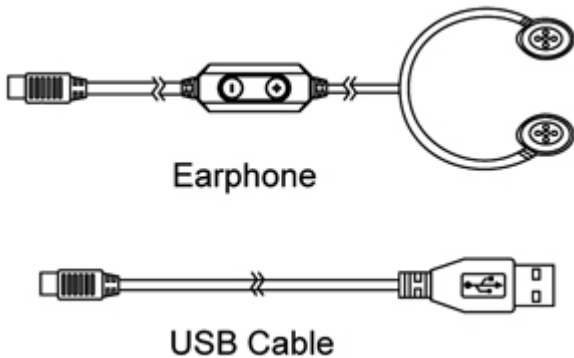

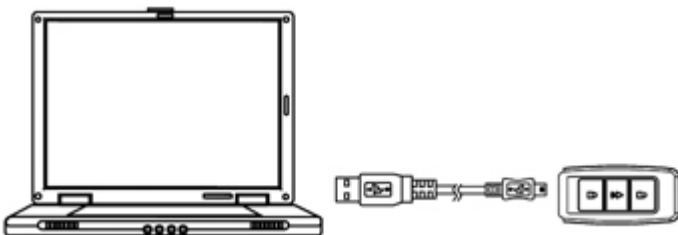

## ■ Charging Battery

1. Turn off the recorder by pressing button 
2. Use USB cable to connect to computer.
3. LED light on the bottom signal: Green
4. Green light turns off when battery is fully charged.



## ■ Operating Recorder





1. Turn on the recorder by pressing button 
2. Setting Recording Mode on left side panel.
  1. Switch to top position to access voice activated recording mode.
  2. Switch to bottom position to access continuous recording mode.
3. Setting Vibration Mode on right side panel.
  1. Switch to top position to turn on vibration alert.
  2. Switch to bottom position to turn off vibration alert.
4. Press  button to start recording.

1. Voice Activated Mode: When audio is detected by internal sensor, recording will start. If no audio is detected in 3 second period, recorder automatically accessing standby mode.
2. Continuous Recording Mode: When recording button is pressed, recording is continuously in operation. Press  button to turn off recording.

## ■ Playback Recorded Files

1. Accessing playback mode by pressing  button.
2. Hook up earphone to listen recorded audio files.

Using controller to:

1. Short press  button to play previous file.
  2. Short press  button to play next file.
  3. Long press  button to increase playback volume.
  4. Long press  button to decrease playback volume.
3. Press  button will erase the current playback file.

## ■ LED Indication

		1. No Light: - Recorder is off.
	 Blue	2. Left No Light, Right Blue: - Recorder is standby. - Blue flash is out of battery.
	 Red    Blue	3. Left Red, Right Blue: - Recorder is recording. - Red flash is memory full.
	 Green	4. Left Green, Right Blue: - Recorder is charging. - Green light off is fully charged.

## ■ Retrieving Recorded Files

1. Use USB cable to connect to computer.
2. Turn on the recorder by pressing button 
3. Click on External Drive, open Record folder.
4. Recorded audio files are located in the folder with initial REC in file name. Copy and paste recorded files to preferred location.